

**KENWOOD**

DIGITAL AUDIO TAPE DECK

**DX-7030**

**INSTRUCTION MANUAL**

KENWOOD CORPORATION

**DAT**

Digital Audio Tape

B60-0297-00 (K,E,T,M,Y) A  
91/12 11 10 9 8 7 6 5 4 3 2 1

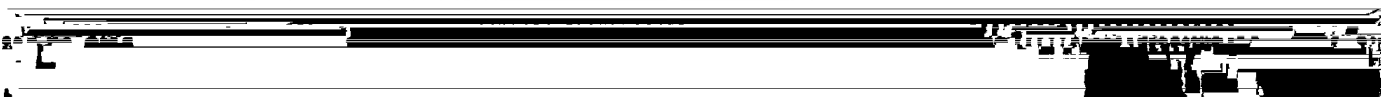

# Introduction

Your choice of this product indicates that you are a devotee to excellence in sound reproduction.

We appreciate your patronage and take pride in the long tradition of quality components that our company represents.

So that you can get the most out of your unit, we suggest that you take the time to read through this manual before you hook up and operate your system. This will acquaint you with operating features and system-connection considerations so that your listening pleasure will be enhanced right from the start. You will notice that in all aspects of planning, engineering, styling, operating convenience and adaptability we have sought to anticipate your needs and desires.

**Keep this manual handy for future reference.**

## For your records

Record the serial number, found on the back of the unit, in the spaces designated on the warranty card, and in the space provided below. Refer to the model and serial numbers whenever you call upon your dealer for information or service on this product.

Model \_\_\_\_\_ Serial Number \_\_\_\_\_

## Unpacking

Unpack the unit carefully and make sure that all accessories are put aside so they will not be lost.

Examine the unit for any possibility of shipping damage. If your unit is damaged or fails to operate, notify your dealer immediately. If your unit was shipped to you directly, notify the shipping company without delay. Only the consignee (the person or company receiving the unit) can file a claim against the carrier for shipping damage.

We recommend that you retain the original carton and packing materials for use should you transport or ship the unit in the future.

## Accessories

- Audio cord ..... 2
- Remote control unit ..... 1



- Battery ("AA" or "R6") .... 2
- Digital cords ..... 2

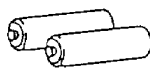

- AC plug adaptor ..... 1  
(Except for some areas)

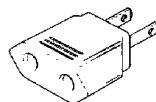

For the unit with a European AC plug in areas other than Europe.

## Contents

**Caution: Read the pages marked  carefully to ensure safe operation.**

<b>Introduction</b> .....	2	<b>Normal playback</b> .....	14
<b>⚠ Before applying power</b> .....	3	<b>Program playback</b> .....	16
<b>⚠ Safety precautions</b> .....	3	<b>Repeat playback</b> .....	18
<b>⚠ IMPORTANT SAFEGUARDS</b> .....	4	<b>Recording</b> .....	19
<b>DAT cassette tapes</b> .....	6	<b>Recording/Deleting IDs (After-recording editing)</b> .....	24
<b>System connections</b> .....	8	<b>Using a timer</b> .....	27
<b>Controls and indicators</b> .....	10	<b>In case of difficulty</b> .....	28
<b>Remote control operation</b> .....	11	<b>Specifications</b> .....	30
<b>Before operation</b> .....	12		

**⚠ Caution: Read this page carefully to ensure safe operation.**

## Before applying power

### For the U.S.A. and Canada

#### Important!

Units shipped to the U.S.A. and Canada are designed for operation on 120 volts AC only.

#### Safety precaution for a Polarized AC plug

However, some products may be supplied with a non-polarized plug.

**CAUTION:** TO PREVENT ELECTRIC SHOCK DO NOT USE THIS (POLARIZED) PLUG WITH AN EXTENSION CORD, RECEPTACLE OR OTHER OUTLET UNLESS THE BLADES CAN BE FULLY INSERTED TO PREVENT BLADE EXPOSURE.

### For the United Kingdom

#### Important!

Units shipped to the U.K. are designed for operation on 240 volts AC only.

The mains plug must be removed from the wall socket prior to any internal examination.

The wires in this mains lead are coloured in accordance with the following code:

Blue ..... Neutral  
Brown ..... Live

The wires in this mains lead must be connected to the terminals in the plug as follows:

Wire colour	Plug terminal marking
Blue .....	N or Black
Brown .....	L or Red

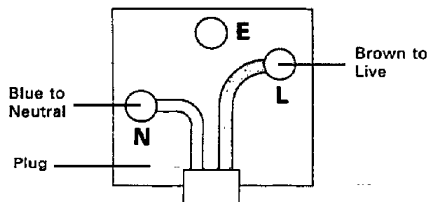

#### Notes:

1. If a 13-amp plug is used, this must be fitted with a 5-amp fuse.
2. If a 3-pin plug with earthing contact is used, no wire must be connected to the E terminal.

### For Australia and Europe

#### Important!

Units shipped to Australia are designed for operation on 240 V AC only.

Units shipped to Europe are designed for operation on 220 V AC only.

### For other countries

#### Important!

Units shipped to countries other than the above countries are equipped with an AC voltage selector switch on the rear panel. Refer to the following paragraph for the proper setting of this switch.

#### AC voltage selection

This unit operates on 110-120 or 220-240 volts AC. The AC voltage selector switch Type A or Type B on the rear panel is set to the voltage that prevails in the area to which the unit is shipped. Before connecting the power cord to your AC outlet, make sure that the setting position of this switch matches your line voltage. If not, it must be set to your voltage in accordance with the following direction.

#### Note:

Our warranty does not cover damage caused by excessive line voltage due to improper setting of the AC voltage selector switch.

#### AC voltage selector switch

##### Type A

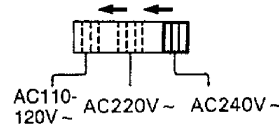

##### Type B



Move switch lever to match your line voltage with a small screwdriver or other pointed tool.

## Safety precautions

**WARNING:** TO PREVENT FIRE OR SHOCK HAZARD, DO NOT EXPOSE THIS APPLIANCE TO RAIN OR MOISTURE.

	<p><b>CAUTION</b> RISK OF ELECTRIC SHOCK DO NOT OPEN</p>		<p>CAUTION: TO REDUCE THE RISK OF ELECTRIC SHOCK, DO NOT REMOVE COVER (OR BACK). NO USER-SERVICEABLE PARTS INSIDE, REFER SERVICING TO QUALIFIED SERVICE PERSONNEL.</p>
	<p>THE LIGHTNING FLASH WITH ARROWHEAD SYMBOL, WITHIN AN EQUILATERAL TRIANGLE, IS INTENDED TO ALERT THE USER TO THE PRESENCE OF UNINSULATED "DANGEROUS VOLTAGE" WITHIN THE PRODUCT'S ENCLOSURE THAT MAY BE OF SUFFICIENT MAGNITUDE TO CONSTITUTE A RISK OF ELECTRIC SHOCK TO PERSONS.</p>		
	<p>THE EXCLAMATION POINT WITHIN AN EQUILATERAL TRIANGLE IS INTENDED TO ALERT THE USER TO THE PRESENCE OF IMPORTANT OPERATING AND MAINTENANCE (SERVICING) INSTRUCTIONS IN THE LITERATURE ACCOMPANYING THE APPLIANCE.</p>		

# IMPORTANT SAFEGUARDS

 **Caution : Read this page carefully to ensure safe operation.**

Please read all of the safety and operating instructions before operating this unit. For best results, follow all warnings placed on the unit and adhere to the operating and use instructions. These safety and operating instructions should be retained for future reference.

**1. Power sources** — The unit should be connected to a power supply only of the type described in the operating instructions or as marked on the appliance.

**2. Power-cord protection** — Power-supply cords should be routed so that they are not likely to be walked on or pinched by items placed upon or against them, pay particular attention to cords at plugs, convenience receptacles, and the point where they exit from the unit.

Never pull or stretch the cord.



**3. Grounding or polarization** — The precautions should be taken so that the grounding or polarization means of this unit is not defeated.

**4. Ventilation** — The unit should be situated so that its location or position does not interfere with its proper ventilation.

To maintain good ventilation, do not put records or a table-cloth on the unit. Place the unit at least 10 cm away from the walls.

Do not use the unit on a bed, sofa, rug or similar surface that may block the ventilation openings.

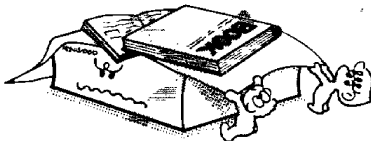

**5. Water and moisture** — The unit should not be used near water — for example, near a bathtub, washbowl, kitchen sink, laundry tub, in a wet basement, or near a swimming pool, etc.

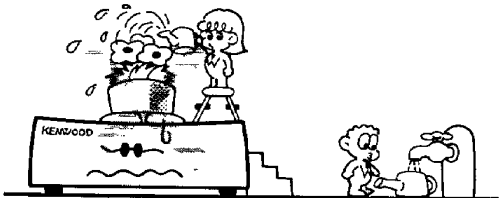

**6. Temperature** — The unit may not function properly if used at extremely low, or freezing temperatures. The ideal ambient temperature is above +5°C (41°F).

**7. Heat** — The unit should be situated away from heat sources such as radiators, heat registers, stoves, or other units (including amplifiers) that produce heat.

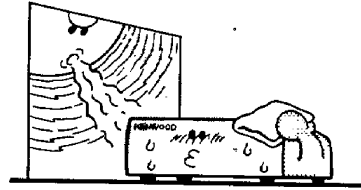

**8. Electric shock** — Care should be taken so that objects do not fall and liquid is not spilled into the enclosure through openings. If a metal object, such as a hair pin or a needle, comes into contact with the inside of this unit, a dangerous electric shock may result. For families with children, never permit children to put anything, especially metal, inside this unit.

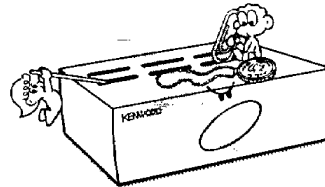

**9. Enclosure removal** — Never remove the enclosure. If the internal parts are touched accidentally, a serious electric shock might occur.

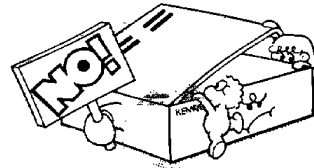

**10. Magnetic fields** — Keep the unit away from sources of magnetic fields such as TV sets, speaker systems, radios, motorized toys or magnetized objects.

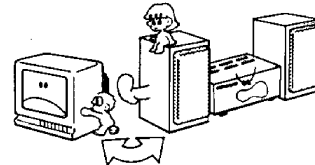

**11. Cleaning** — Do not use volatile solvents such as alcohol, paint thinner, gasoline, or benzene, etc. to clean the cabinet. Use a clean dry cloth.

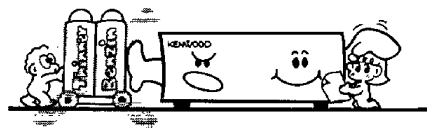

**⚠ Caution : Read this page carefully to ensure safe operation.**

**12. Carts and stands** — An appliance and cart combination should be moved with care. Quick stops, excessive force, and uneven surfaces may cause the appliance and cart combination to overturn.



**13. Nonuse periods** — The power cord of the unit should be unplugged from the outlet when left unused for a long period of time.

**14. Abnormal smell** — If an abnormal smell or smoke is detected, immediately turn the power OFF and pull out the power cord. Contact your dealer or nearest service center.

**POWER OFF!**

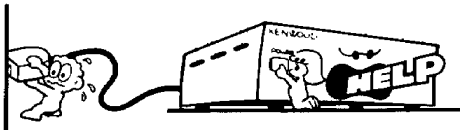

**15. Damage requiring service** — The unit should be serviced by qualified service personnel when:

- A. The power-supply cord or the plug has been damaged; or
- B. Objects have fallen, or liquid has been spilled into the unit; or
- C. The unit has been exposed to rain; or
- D. The unit does not appear to operate normally or exhibits a marked change in performance; or
- E. The unit has been dropped, or the enclosure damaged.

**16. Servicing** — The user should not attempt to service the unit beyond that described in the operating instructions. All other servicing should be referred to qualified service personnel.

**17. Outdoor antenna grounding** — If an outside antenna is connected to the receiver, be sure the antenna system is grounded so as to provide some protection against voltage surges and built up static charges. Section 810 of the National Electrical Code, ANSI/ NFPA No. 70—1984, provides information with respect to proper grounding of the mast and supporting structure, grounding of the lead-in wire to an antenna discharge unit, size of grounding con-

ductors, location of antenna-discharge unit, connection to grounding electrodes, and requirements for the grounding electrode. See Figure.

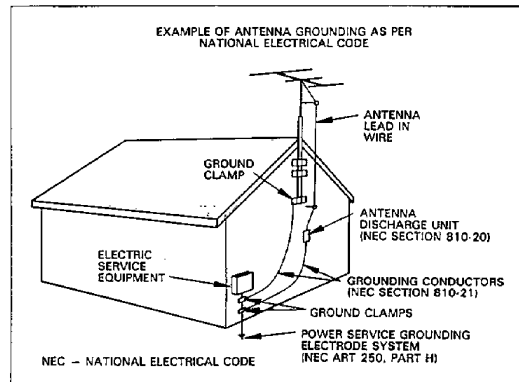

**18. Power lines** — An outdoor antenna should be located away from power lines.

**Notes:**

1. Item 3 is not required except for grounded or polarized equipment.
2. Item 17 and 18 are not required except for units provided with antenna terminals.
3. Item 17 complies with UL in the U.S.A.

# DAT cassette tapes

**DAT cassette tapes are only half the size of conventional compact cassette tapes. They are also more hermetically designed to prevent the penetration of dust.**

**Recording or playback of DAT cassettes is only possible on one side.**

**To make full use of the high sound quality of digital audio, please follow these precautions:**

## ■ Precautions for use

When a cassette is brought from a cold exterior to a warm room, drops of water may form on the tape surface (condensation). As a tape containing moisture may be damaged if used, leave the tape at room temperature for one hour or more before use to ensure that the drops have disappeared. DAT cassettes cannot be used upside down.

Insert cassette  
in this manner.

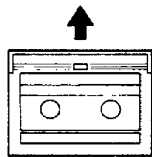

Cassette cannot be  
used upside down.



The tape cassette is a precision-built mechanism. Never attempt to disassemble it.

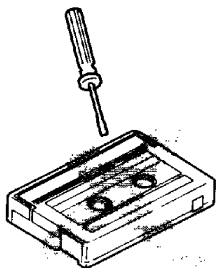

Do not attempt to open the cassette lid by force, or to touch the tape with your hand.

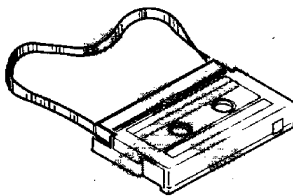

Do not repeatedly insert and eject a cassette without playing or recording the tape, as the tape may become slack or damaged.

## ■ Precautions for storage

Store a cassette in its case.

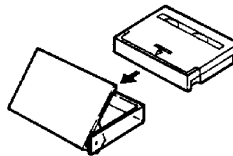

Avoid dusty or dirty places.

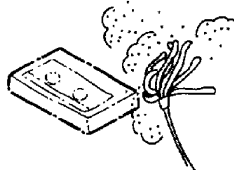

Avoid places subject to direct sunlight, near heat sources such as heating equipment, or places where the humidity is high.

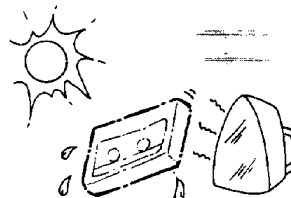

Never place the cassette on the dashboard or near the rear window of a car.

To prevent the loss of a valuable recording, avoid sources of strong magnetism, such as magnets, speakers, TVs, transformers, and motors.

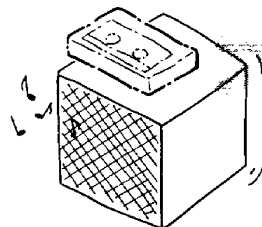

After use, store the cassette with the tape rewound completely. The tape may be damaged if it is not rewound properly.

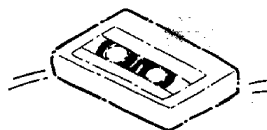

## ■ To prevent accidental erasure of a recording

To prevent accidental erasure of valuable recordings, DAT cassette tapes are provided with an "eraser protection slider."

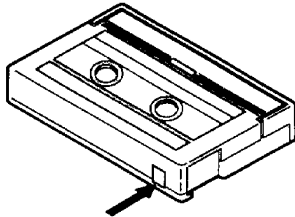

"Accidental erasure protection slider"

To prevention accidental erasure

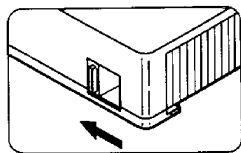

Slide toward the left until the window is fully open.

Before recording

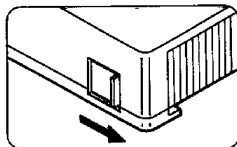

Slide toward the right until the window is fully closed.

### Notes:

1. Do not insert objects into the rectangular hole on the front side of the tape cassette, or cover it by applying anything over it.
2. Do not insert objects into the rectangular hole on the back side of the tape cassette, or cover it by applying anything over it.
3. Do not mount or apply a cassette stabilizer or any other object to the cassette, as this may prevent the cassette from ejecting.

## ■ Be careful of condensation

When a bottle or other type of container is taken out of a refrigerator, the warm air of the room causes water drops to form on the container's surface. This is called condensation.

If condensation occurs inside the tape deck, the tape will stick to the internal mechanisms causing the deck to operate abnormally or to stop operating completely. It may also cause damage to the tape or internal parts.

The deck automatically checks for condensation when the power is turned on.

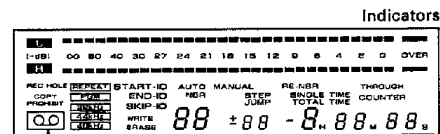

(Blinks when a tape is being loaded.)

If condensation is detected, this indicator blinks rapidly. At this time, leave the unit until condensation disappears. The operation keys do not function during this period. Once the condensation has evaporated, the indicator stops blinking and the unit enters normal operation mode.

### Be especially careful in the following conditions.

- When the unit is brought from a cold place to a warm place, and there is a large temperature difference.
- When a heater starts operating.
- When the unit is brought from an air-conditioned place to a place of high temperature with high humidity.
- When there is a large difference between the internal temperature of the unit and the ambient temperature, or in conditions where condensation occurs easily.
- When a cassette is brought from a cold exterior to a warm room, condensation may form on the tape surface. As a tape containing moisture may be damaged if used, leave the tape at room temperature for one or two hours before use to ensure that the condensation has disappeared.

# System connections

Make connection as shown in the diagram below. When connecting the related system components, refer also to the instruction manuals of the related components.  
Do not plug in the power lead until all connections are complete.

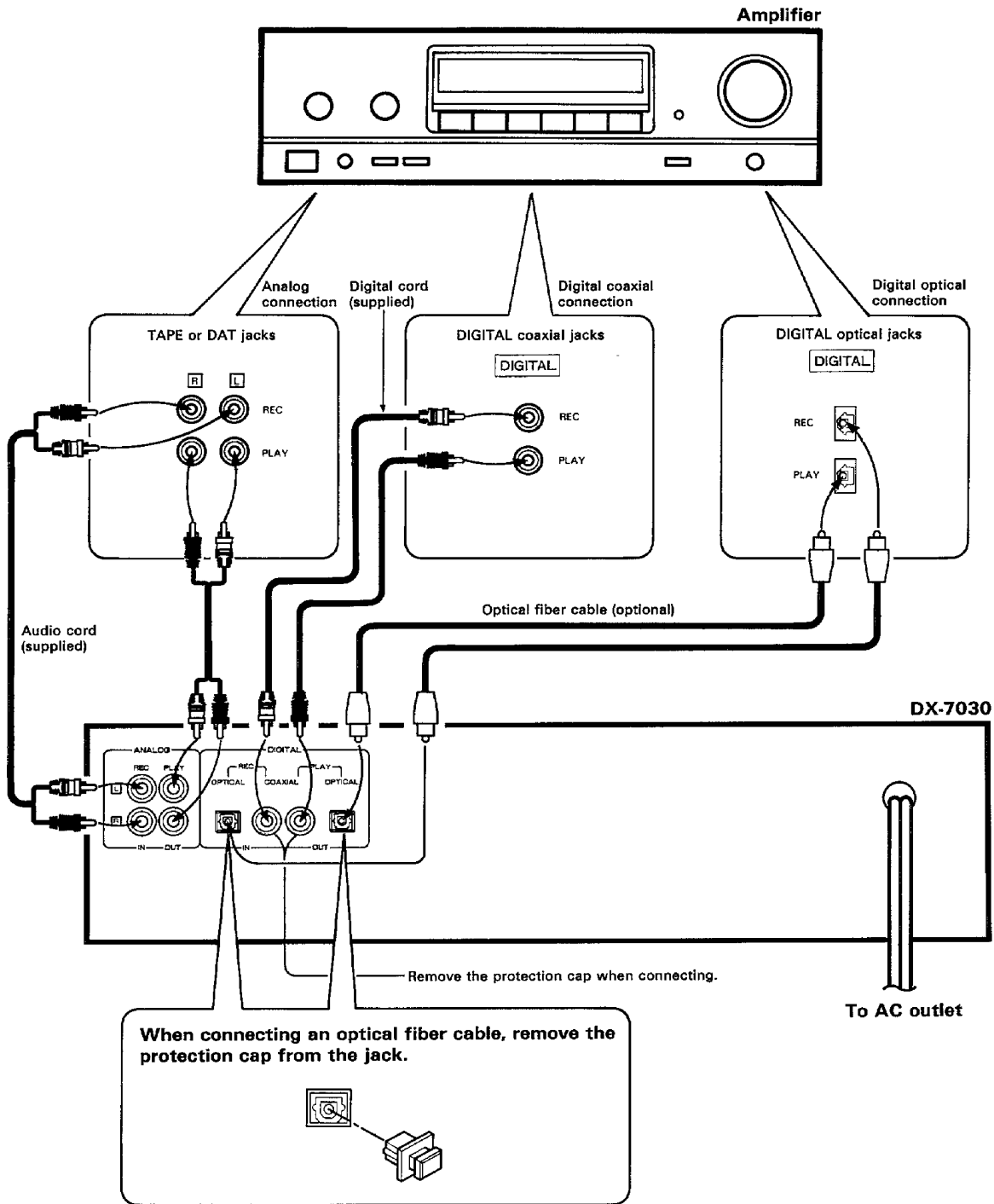

**Notes:**

1. Be sure to connect the connection cord(s) securely. If connections are not made securely, sound may not be produced and/or noise may be generated. Improper connections can also cause player misoperation.
2. Before plugging/unplugging connection cords, be sure to switch the power off and set amplifier's volume control to its minimum position. If connection cords are plugged or unplugged without carrying out the above precautions, malfunction or damage may result.



## ■ Connection with amplifier (The following three connection methods are available.)

### Connection with a general amplifier (analog connection)

Connect this unit's analog recording jacks (ANALOG REC IN) and playback jacks (PLAY OUT) to the amplifier's tape jacks (TAPE or TAPE/DAT) using the supplied audio cords, being careful to correctly connect corresponding left and right channels.

### Optical fiber cable connection (digital OPTICAL connection)

This unit's digital optical recording jack (OPTICAL REC IN) and playback jack (OPTICAL PLAY OUT) can be connected to an amplifier or DA converter equipped with optical in/out jacks (OPTICAL IN/OUT).

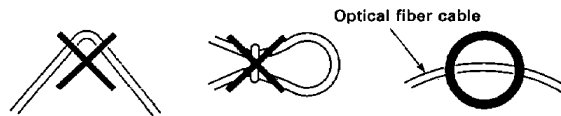

Do not sharply bend the optical fiber cable.

### Digital coaxial cord connection (digital COAXIAL connection)

This unit's digital coaxial recording jack (DIGITAL REC IN) and playback jack (DIGITAL PLAY OUT) can be connected to an amplifier or DA converter equipped with a digital in jack (DIGITAL IN) or digital in/out jacks (DIGITAL IN/OUT).

#### Notes:

1. If your amplifier is equipped with both optical fiber input/output connection jacks and digital (coaxial) cord input/output connection jacks, use only one of the jack types. If both types are connected, malfunction may occur.
2. Some makes of optical fiber cables may not be able to be used with this unit. If connection is not possible, consult your dealer or nearest sales location.
3. Be careful not to connect a digital (coaxial) cord to an analog jack (PHONO, CD, TUNER, AUX, TAPE LINE IN) on your amplifier, as this may damage your amplifier or speakers.

# Controls and indicators

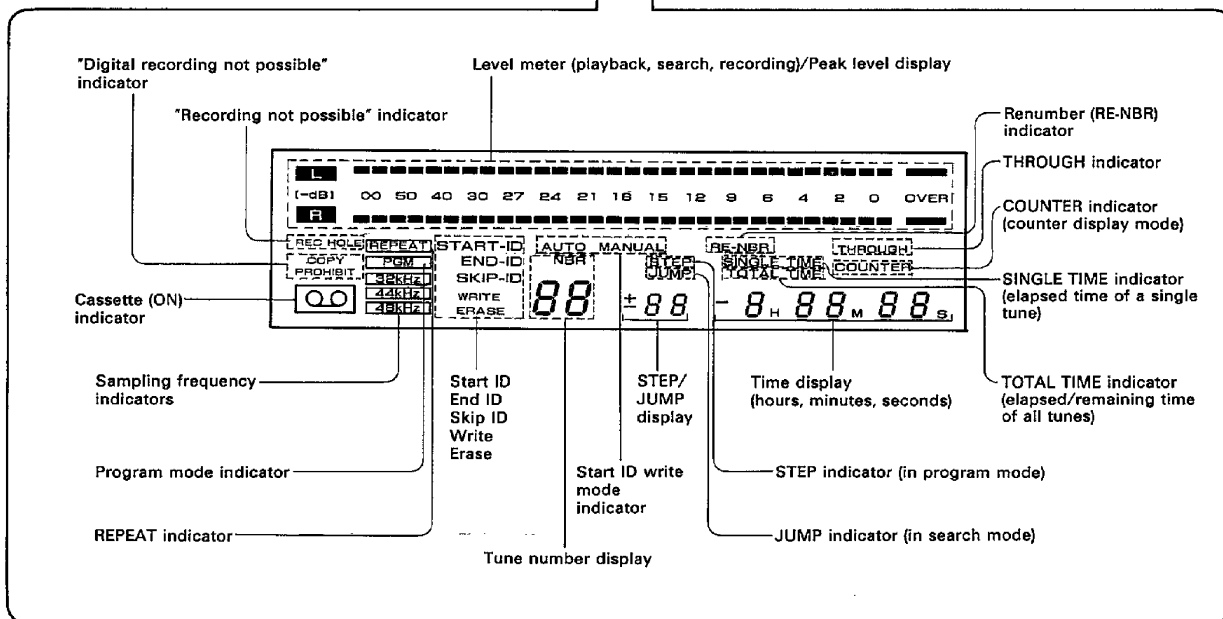
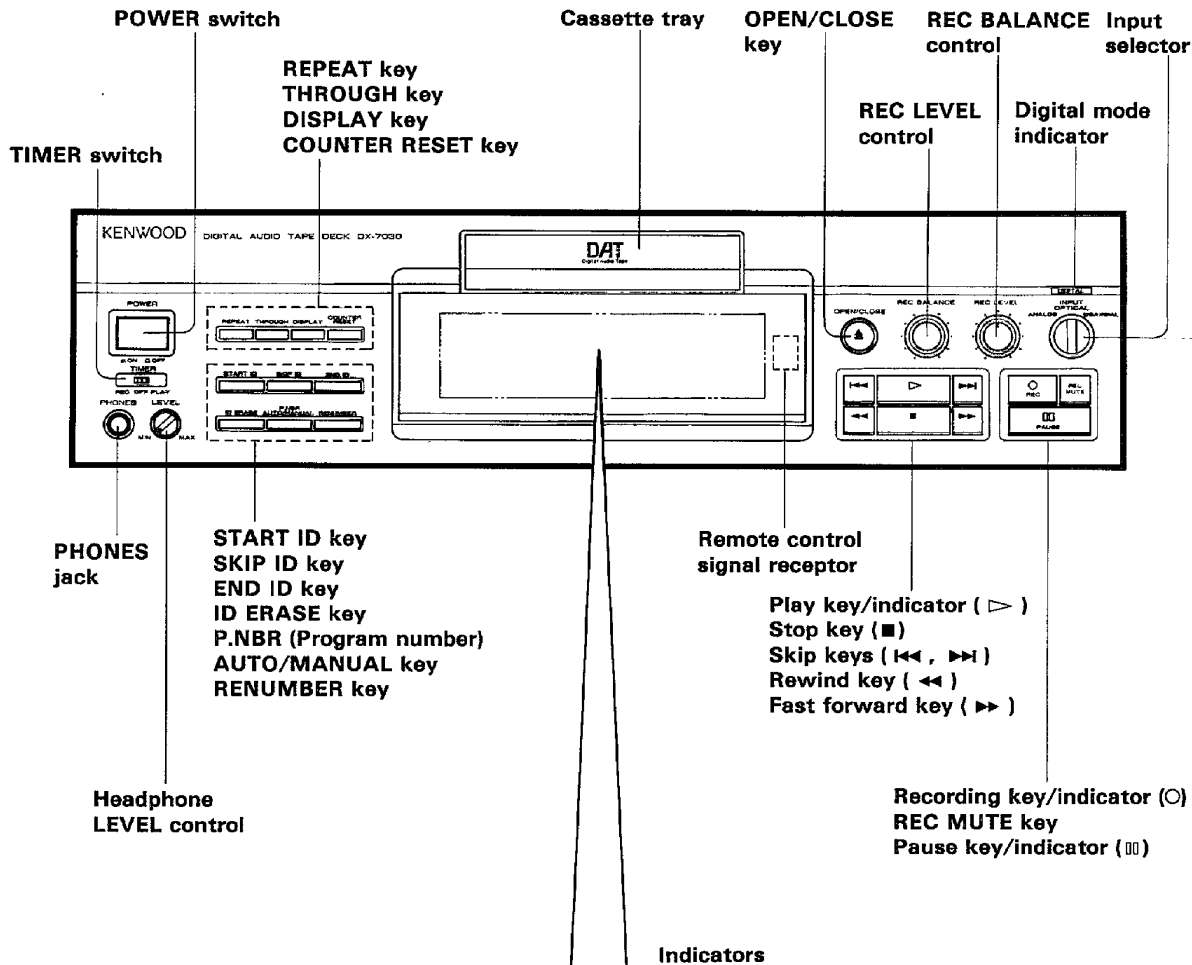

# Remote control operation

Keys marked with an asterisk (\*) are provided only on the remote control unit.

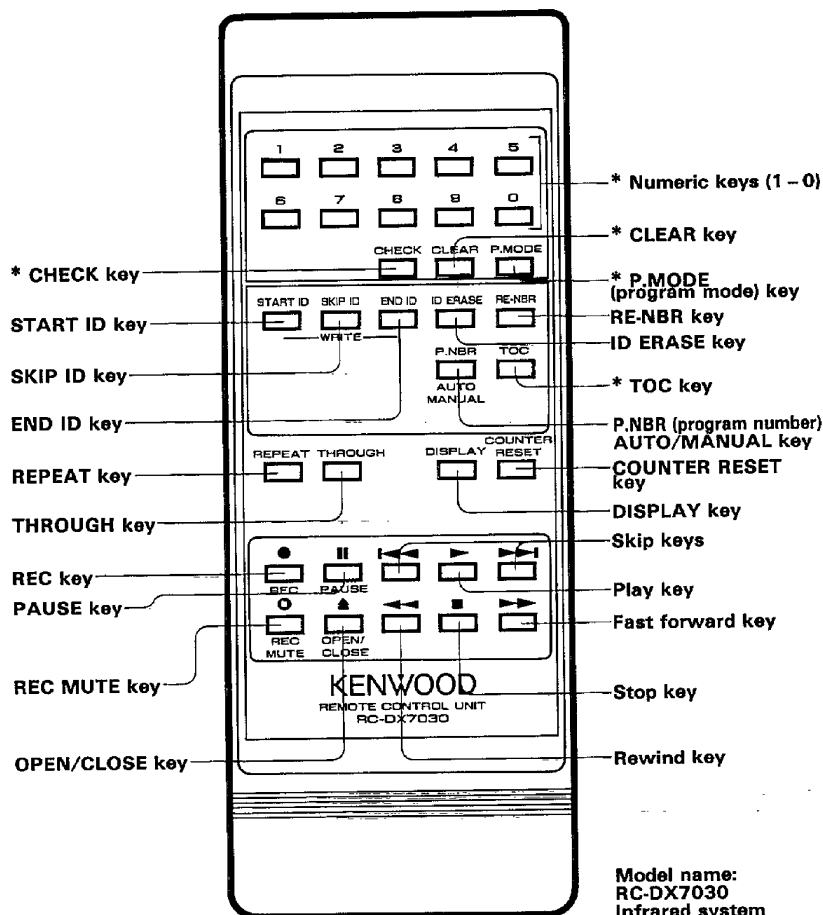

## ■ Loading batteries

### 1 Remove the cover.

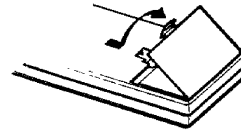

### 2 Insert batteries.

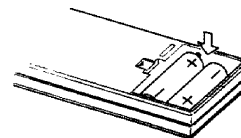

Insert two AA-size (R6) batteries as indicated by the polarity marking.

### 3 Close the cover.

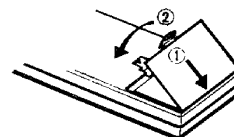

## ■ Operation procedure

The operation range of the remote control unit varies according to conditions such as temperature, humidity, and use location, but is roughly as shown in the illustration below.

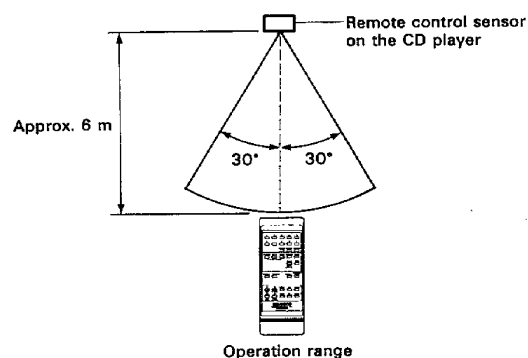

- Wait at least one second after pressing an operation key on the remote control unit before pressing another key.
- If other key is pressed just after a key is pressed, the unit sometimes malfunctions.

### Notes:

1. The supplied batteries are intended for use in operation checks. Therefore, their lives may be shorter than ordinary batteries.
2. When the remote-controllable distance gets shorter than before, replace both batteries with new ones.
3. Malfunction may occur if direct sunlight or the light of a high-frequency lighting fluorescent lamp enters the remote control light sensor. In such a case, change the system installation position to prevent the malfunction.

# Before operation

## Subcodes

The DAT system records subcodes on the tape along with the recorded music signal to assist in tune selection and editing and improve overall operability.

Commercially-available prerecorded DAT music tapes are already recorded with these subcodes.

\* Subcode

Name	Function	Recording time/position
<b>Start ID*</b>	Indicates the start of a tune. Used for operations such as tune skipping. When recording your own tapes, tune numbers can be automatically or manually recorded by setting the P.NBR key to AUTO or MANUAL. Subcodes can be freely recorded, deleted, and changed. (See "Recording/Deleting IDs" on page 24.)	9 seconds at the start of a tune. (Can also be inserted at any other desired position.)
<b>Skip ID*</b>	During playback the deck skips from this ID to the next Start ID and resumes playback.	1 second at the designated position.
<b>End ID*</b>	Indicates the end of a recording. The deck automatically stops when this ID is detected during playback or fast-forwarding. When continuing a recording from the end of a previous recording, this ID is used to locate the start point.	9 seconds at the end of recording.
<b>Tune number* (NBR)</b>	Numerical value indicating the number of a tune.	9 seconds at the start of a tune. (With commercially-available prerecorded tapes, these numbers are recorded throughout the entire tape.)
<b>A TIME (TOTAL TIME)*</b>	Elapsed time from the start of the tape.	Recorded throughout the entire tape.
<b>P TIME (SINGLE TIME)</b>	Elapsed time of a single tune.	9 seconds at the start of a tune.
<b>TOC data</b>	Data such as the number of tunes on the tape and the recording time.	Recorded at the start of the first tune on the tape.

Tape running direction →

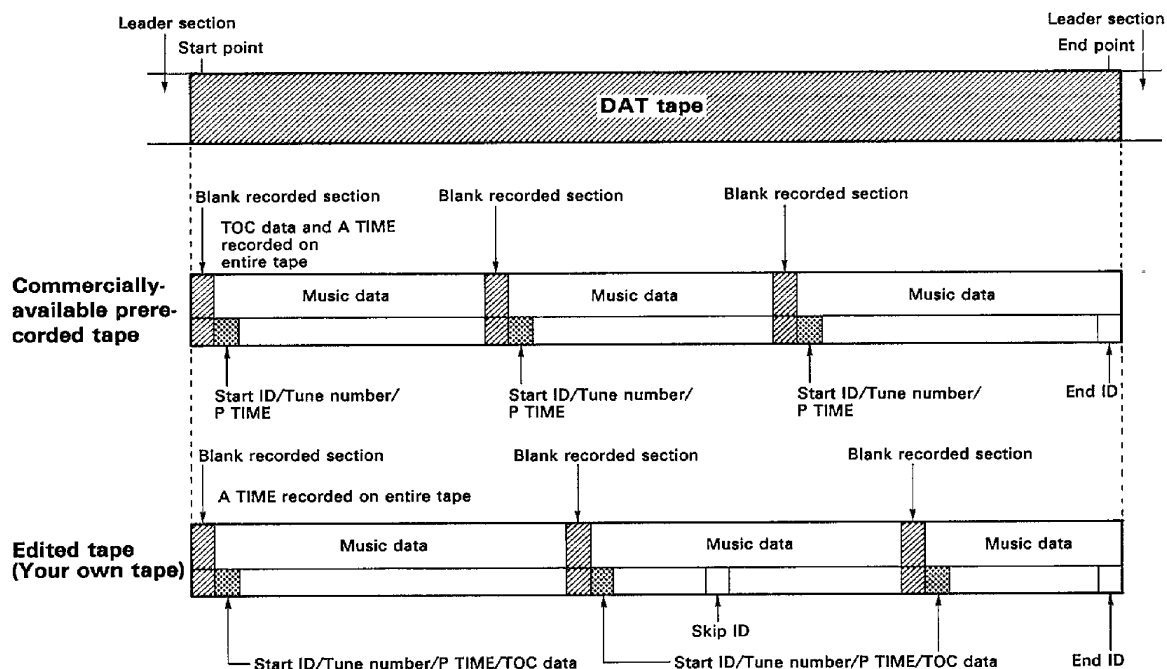

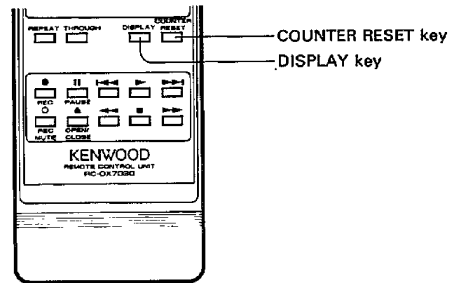
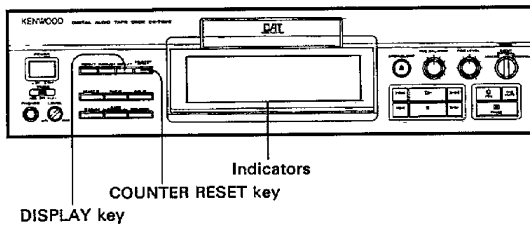

## ■ Switching the time display

**DISPLAY**



- Each press of the DISPLAY key changes the time display according to the following sequence:
  - ① Total elapsed time of the tape (TOTAL TIME) (A TIME)  

1 H 23 M 46 S
  - ② Elapsed time of the currently playing tune (SINGLE TIME) (P TIME)  

02 M 23 S
  - ③ Total remaining time of all tunes or entire tape (REMAIN TIME)
    - During playback, the recorded remaining time is displayed after reading the TOC.
    - During recording: Indicates the remaining time to the end of the tape (in minute units).

- 2 M 30 S
  - ④ Tape counter  

12 34

**Note:**  
 On most commercially-available prerecorded music tapes, subcodes such as the tune number (NBR), the signal indicating the start of each tune (Start ID), and the elapsed time for each tune are recorded in standard locations. If a tape does not contain one or more of these subcodes, the display or operation may differ from the above description.

### Counter display

- To reset the counter value to "0000".

### COUNTER RESET



- Reset the counter when the time display is in "tape counter mode."
- The counter display counts from "0000" to "9999".
- If the tape is rewound from the "0000" position, the counter counts down to "9999", "9998", etc.

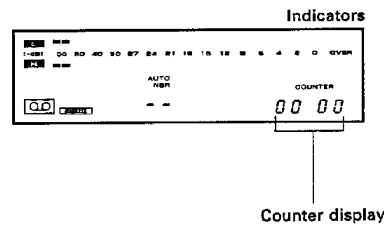



When the power is turned off the counter automatically resets to "0000". Use the counter as a guide to the tape running position.

**Note:**  
 Discrepancies in the counter value may occur depending on factors such as the tape type and operation mode.

# Normal playback

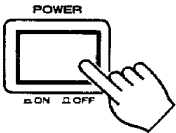
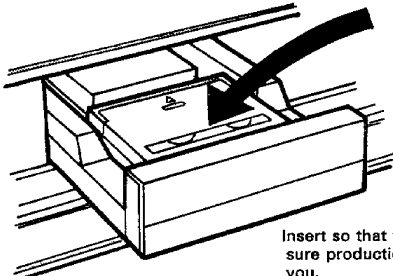
## ■ Loading a cassette tape

<p><b>1</b> Turn on the power.</p> 	<ul style="list-style-type: none"> <li>• Be careful not to mistake the up and down sides of the cassette.</li> </ul>  <p>Insert so that the "accidental erasure production slider" faces you.</p> <p>Hold the cassette with the label facing up, and push the tray gently.</p>
<p><b>2</b> Open the tray and insert a tape.</p> 	
<p><b>3</b> Close the tray.</p>  <ul style="list-style-type: none"> <li>• When not using the unit, remove the tape and turn off the power.</li> </ul>	

## ■ To play a tape

The displayed indicators are examples.

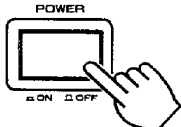
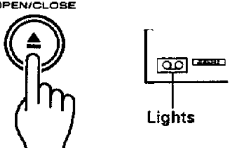
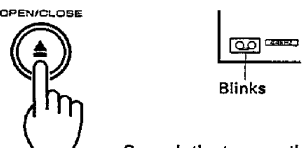
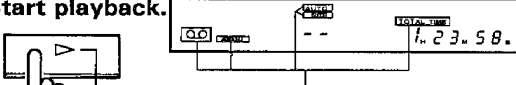
<p><b>1</b> Turn on the power.</p> 
<p><b>2</b> Open the tray and insert a tape.</p> 
<p><b>3</b> Close the tray.</p>  <p>Or push the tray gently.</p>
<p><b>4</b> Start playback.</p>  <p>During operation: Lights During standby: Blinks</p> <ul style="list-style-type: none"> <li>• If you press the play button before closing the tray, the tray automatically closes and playback starts.</li> </ul>

## ■ To stop playback

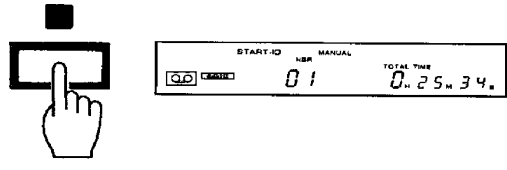

## ■ Listening through headphones

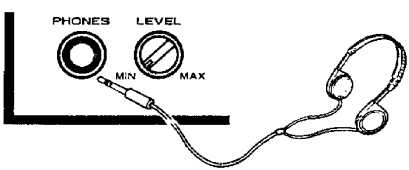
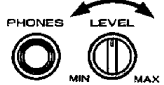
<p><b>1</b> Plug in the headphones plug to the PHONES jacks.</p> 
<p><b>2</b> Adjust the volume.</p> 

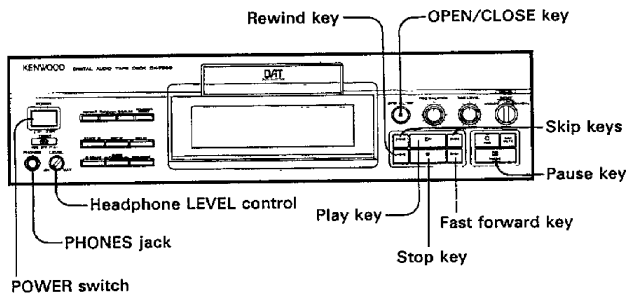

## ■ To pause playback

- To cancel, press the stop key to enter the stop mode or press the play key to enter the play mode.

## ■ Playing a desired tune

**Skip operation: Skips to the beginning of the designated tune and starts playback.**

Press the skip key corresponding to the desired skip direction.

- You can designate the tune you want to play by repeatedly pressing the same key or by holding the key pressed.
- If a skip key is pressed in stop mode, the deck searches for the designated tune and starts playback.
- If the [Previous] key is pressed once during playback, the deck returns to the beginning of the current tune and plays the same tune again.

### Notes:

1. The skip function may not operate correctly with tunes 30 seconds or shorter in length.
2. If a Start ID does not exist at the location specified using the skip key, the deck enters stop mode after searching for the tune.
3. If playback is started from the middle of a tune, the tune number (NBR) display may show "--" while the tune is playing.
4. If a tape is not recorded with tune numbers, the tune number (NBR) display will show "--".

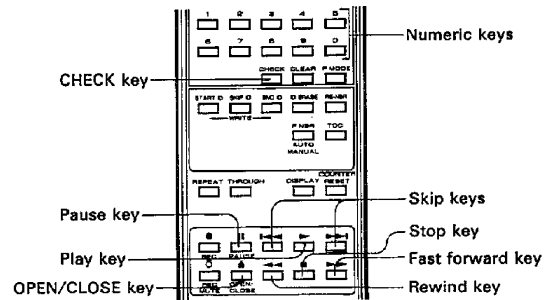

## ■ Starting playback using the remote control unit's numeric keys (The tape should be recorded with tune numbers.)

**1 Select the desired tune number.**

To select a tune number of 10 or greater  
Example: Tune number 12

**2 Start playback.**

### Notes:

1. The numeric keys (1-0) can be used to designate tune numbers (NBR) ranging from 1 to 99.
2. If the tape has no tune number (NBR) or if the tune number does not correspond to the order of the tune, the numeric keys (1-0) and skip keys cannot be used to select tune.
3. If you designate a tune number (NBR) which is not recorded on the tape, the deck will stop.

## ■ Locating tunes using the fast-forward and rewind functions

- When pressed during stop mode, the tape is advanced/reversed at high speed. Locate the desired tune using the counter display or time display as a guide.
- When pressed during playback, the tape is played in the forward or reverse direction at high speed and a low-level playback sound can be heard. When the tape reaches the desired location, release the key to resume playback.

# Program playback

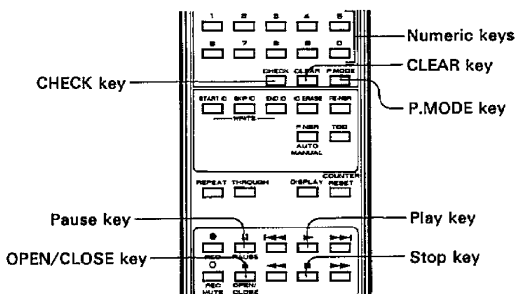
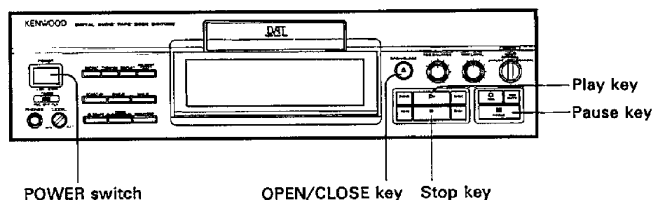

## ■ Programming tunes

### 1 Load a tape which contains tune numbers.

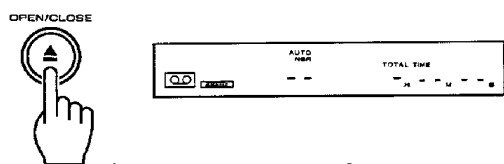

### 2 Set the deck to program mode.

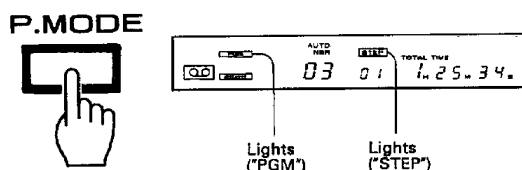

- Press when the deck is in stop mode.

### 3 Select a tune number.

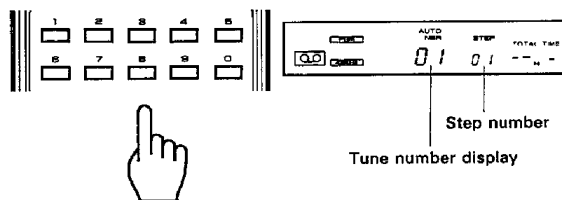

### 4 Input the tune.

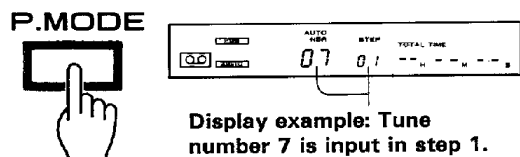

- The P.MODE key has two functions: it turns the program mode ON/OFF and inputs tunes into the program.

#### To continue inputting tunes

You can repeat steps 3 and 4 to program up to 32 tunes (32 steps). Programming is not possible during playback.

## ■ Checking the program contents

### CHECK

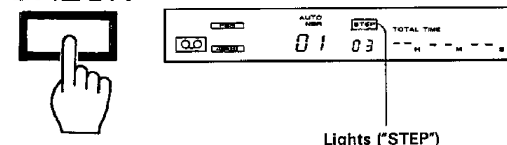

- Each time the CHECK key is pressed, the next programmed tune number is displayed according to the programmed sequence.

## ■ Playing a program

### Start playback.

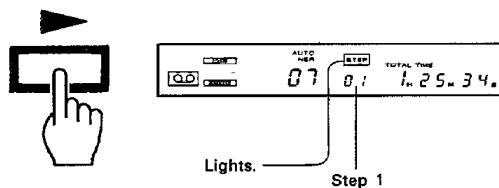

**Example: When tune number 7 is programmed in step 1.**

- Playback starts from step 1.

#### Notes:

1. The numeric keys (1 - 0) can be used to designate tune numbers (NBR) ranging from 1 to 99.

2. If the tape has no tune number (NBR) or if the tune number does not correspond to the order of the tune, the numeric keys (1 - 0) and skip key cannot be used to select tune.
3. If you designate a tune number (NBR) which is not recorded on the tape, the deck will stop.



## ■ Changing the program contents

**1** Set to stop mode.



**2** Display the tune number (step) you want to change.

CHECK

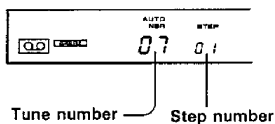

Example: When step 2 is programmed as tune number 8.  
Press the CHECK key twice.

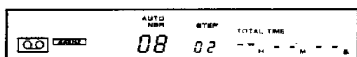

**3** Reprogram the step.

Change the contents of step 2 from tune number 8 to tune number 7.

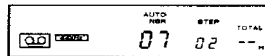

Press 7.

**4** Finish the change operation.

P.MODE



The next step is displayed.

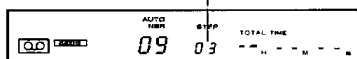

## ■ Stopping program playback

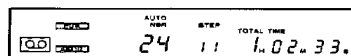

- Playback stops. The program contents remain in memory.

## ■ To erase the entire program contents

P.MODE

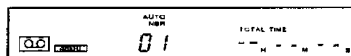

- Pressing the P.MODE key in stop mode cancels program mode and erases the program contents.
- Pressing the CLEAR key erases the program contents one step at a time from the last step.

CLEAR



- Pressing the OPEN/CLOSE key erases the program contents.
- Turning off the power also erases the program contents.

# Repeat playback

Single, whole or programmed tunes can be played back repeatedly.

## ■ One-tune repeat playback

**1 Create a program (one tune only).**

**2 Set the deck to repeat mode.**

**3 Start playback.**

**To cancel one-tune repeat playback:**

Press the REPEAT key again.

- Program playback resumes.

## ■ Program repeat playback

**1 Create a program (several tunes).**

**2 Set the deck to repeat mode.**

**3 Start playback.**

**To cancel program repeat playback**

Press again.

- Program playback resumes.

## ■ All-tune repeat playback

This function repeatedly plays all of the tunes on the tape.

**REPEAT**

**To cancel all-tune repeat playback**

**REPEAT**

Press again.

- Normal playback resumes.
- Opening the tray also cancels repeat playback.

Note:  
Repeat playback is automatically canceled after 15 repeats.

# Recording

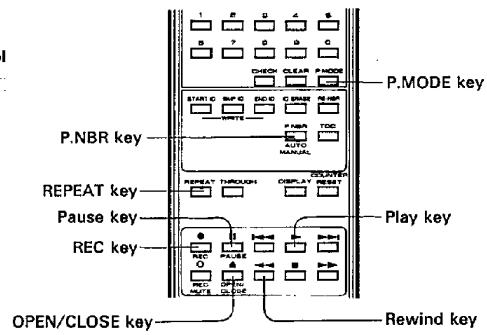
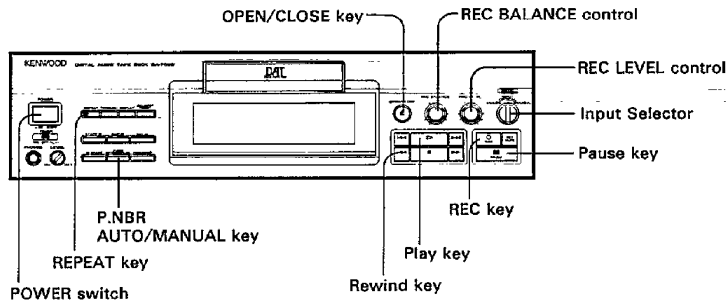

## ■ Analog recording

(Recording from the start of the tape.)

**1 Turn on the power.**

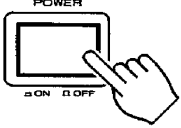

**2 Load a recording-use tape.**

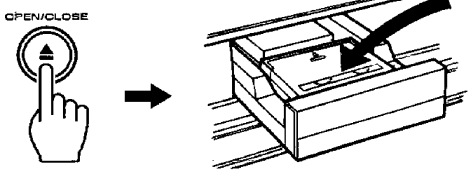

- Verify that the "accidental erasure protection slider" is closed.

**3 Rewind the tape.**



**4 Select the tune number recording mode.**

P.NBR



AUTO/MANUAL

AUTO: The "AUTO" indicator lights.  
MANUAL: The "MANUAL" indicator lights.

- For details about the P.NBR key, see page 23.
- When the power is supplied, the unit is set to AUTO mode.

**5 Set to ANALOG.**

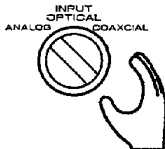
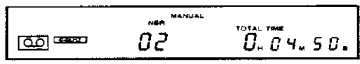
**6 Set the deck to record-standby mode.**

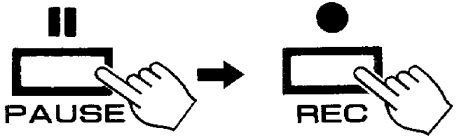

**7 Adjust the recording level and balance.**

Level and left/right balance

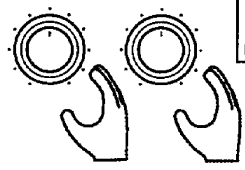
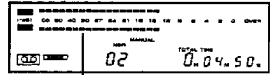
- Play the source to be recorded and adjust the REC LEVEL control to an appropriate position. (See page 20.)

**8 Start recording.**

REC key on the main unit

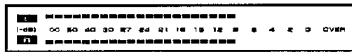

During operation: Lights

- If a recorded tape contains a blank, non-recorded section, it may take longer than usual for the deck to locate the beginning of a tune, or the elapsed time may change while the tape is playing. When recording from the middle of a tape, refer to "Contiguous recording" on page 21.

Note:  
Analog input signals are always recorded at a sampling frequency (FS) of 48 kHz.

## Recording

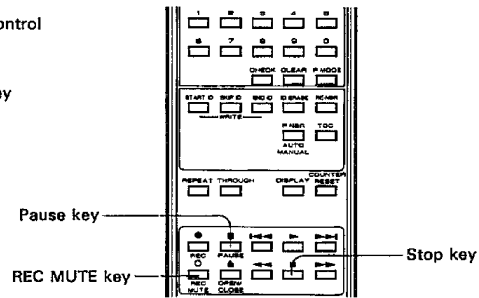
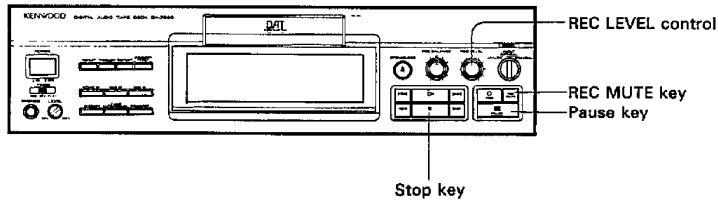

### ■ Pausing recording

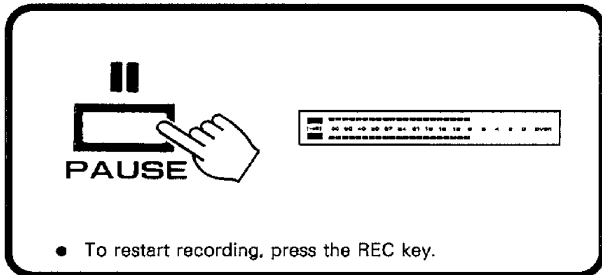

### ■ Stopping recording

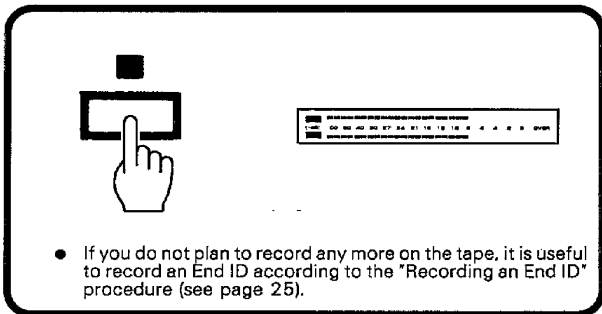

### ■ To create a blank recorded section during recording or in record-pause mode

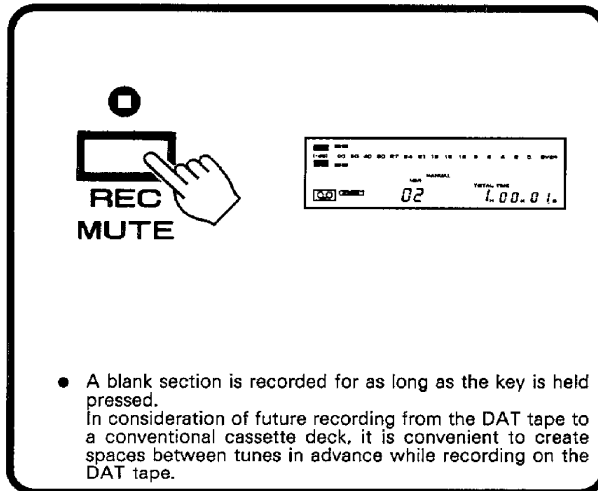

### Setting the recording level (reference example)

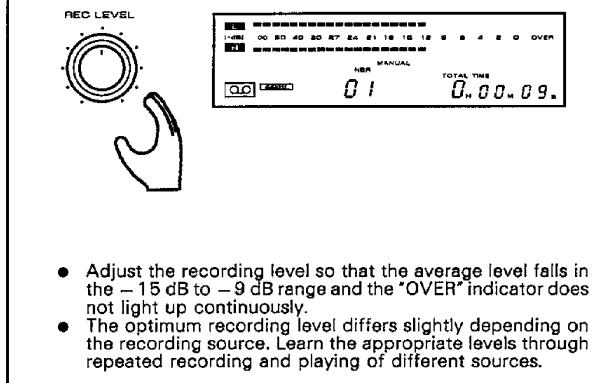

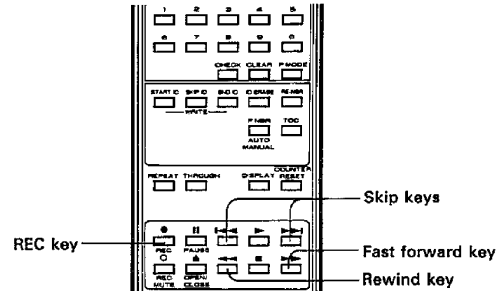
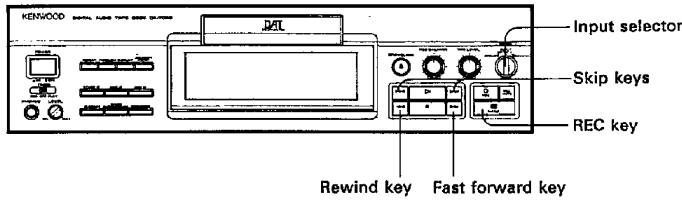

## Digital recording

Digital recording allows you to make recordings true to the original.

### 1 Select a digital source.

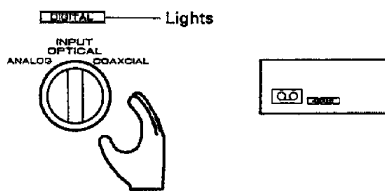

- Select the OPTICAL or COAXIAL input, whichever is connected.

### 2 Record the tape using the same procedure as for analog recording.

- Load a recording-use tape.
  - Set the tape to the recording start point (using the ◀◀ key, etc.)
  - Select the tune number recording mode.
  - Press the REC key.
  - Play the recording source.
- It is not necessary to set the recording level.
  - When recording from a BS tuner, if the broadcast mode (A mode or B mode) changes during recording, the deck temporarily enters record-pause mode and then automatically restarts recording.

#### Notes:

- If the "COPY PROHIBIT" indicator lights, the deck is in recording prohibit mode. (See page 22.)
- If the sampling frequency changes in the middle while a digital signal is being recorded, the deck enters record-pause mode for a few seconds and then resumes recording.
- If the input selector is set to a digital position (OPTICAL or COAXIAL) but a digital signal is not input when recording is started, the deck enters record-pause mode (the "DIGITAL" indicator blinks) and automatically starts recording when a digital signal is input.
- If the digital signal is interrupted during recording due to an amplifier switching operation, etc., the pause indicator lights and the unit enters record-pause mode. The deck automatically restarts recording when the digital signal is input again.

## Erasing a recording

When a recorded tape is re-recorded, the previously recorded contents are erased.

## Contiguous recording

What is "contiguous recording"?

The contiguous recording function starts a new recording from the end of a previous recording and continues the same tune number (NBR) sequence and elapsed time sequence of the previous recording.

Using this function you can create a tape which has no blank recorded space between tunes and which has a single continuous sequence of tune numbers (NBR) and elapsed time data.

### 1 Check the tune number./Set to stop mode.

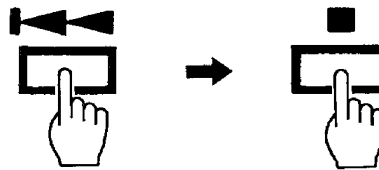

- Press in stop mode.
- To check the previous tune number, press the ◀◀ skip key.
- You do not need to press the key if the tune number is already checked.

### 2 Search for the contiguous start point./Set to rec pause mode.

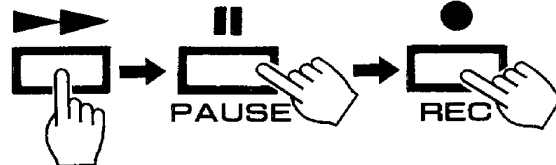

- The deck searches for the end of the recorded section and stops at that position.

### 3 Start recording.

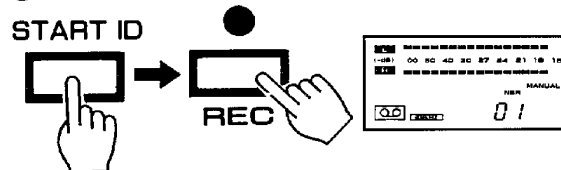

- The deck automatically continues the previously recorded tune number sequence.
- If tune numbers are not recorded on the tape, the new recording is made with undetermined tune numbers ("—" is displayed).
- Even if Start IDs are recorded with undetermined tune numbers, you can go back later and rewrite all of the tape's tune numbers in a continuous sequence using the "To rewrite tune numbers" procedure (see page 25).

## Recording

### Sampling frequency

The sampling frequency is the division frequency used when an analog waveform is converted to digital.

The sampling frequency indicators light up according to the sampling frequency of the current input source.

32kHz: When a BS tuner is recorded or played in A mode; long playback DAT tapes

44kHz: When CDs or DAT music tapes are recorded or played

48kHz: When a BS tuner is recorded or played in B mode; when recording from an analog signal

32kHz

44kHz

48kHz

Indicators

### Copy prohibition code (SCMS: Serial Copy Management System)

Sources which contain a copy prohibition code can be recorded only once.

#### When recording from an analog signal

Analog input sources do not contain copy prohibition codes and can be recorded as many times as desired.

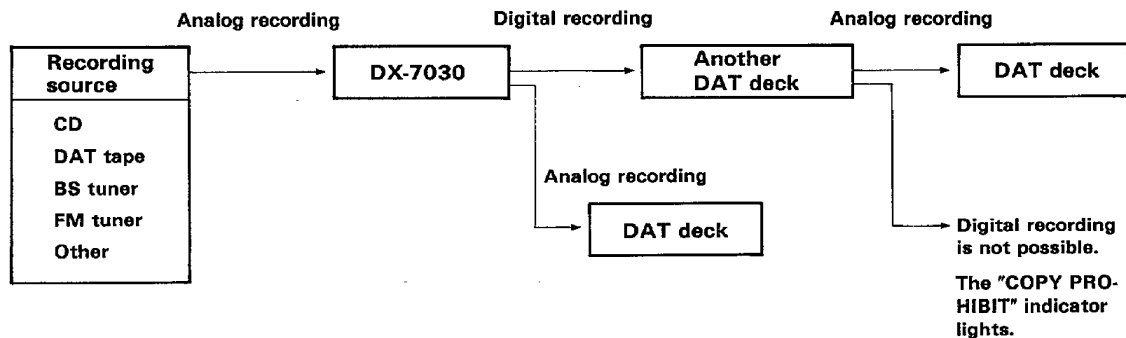

#### When recording from a digital source

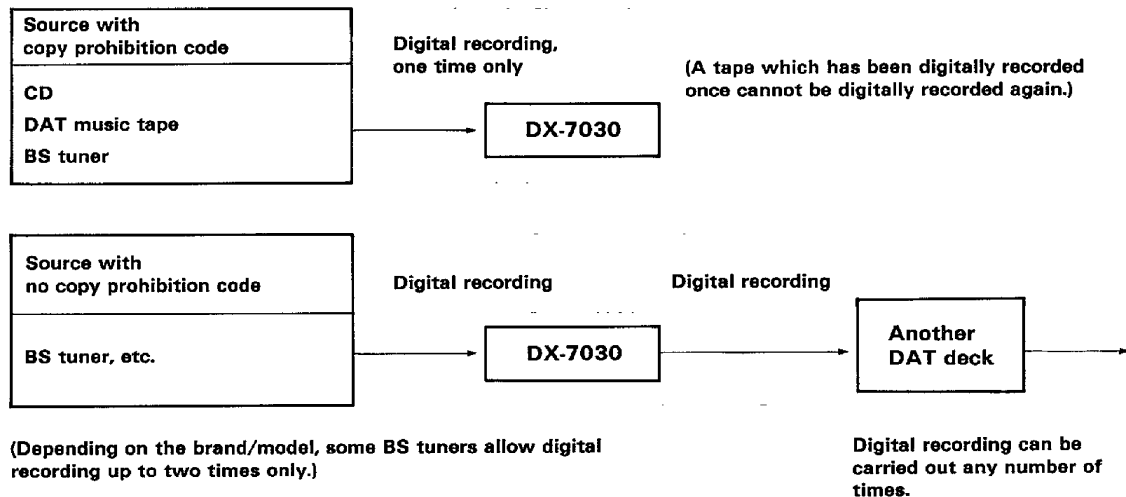

### P.NBR key

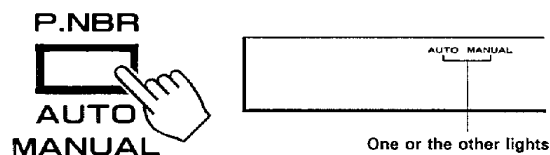

This key switches the tune number (NBR) recording mode between auto mode and manual mode.

#### Auto mode ("AUTO" indicator lights):

In this mode, a tune number and Start ID are automatically recorded.

When the recording has been started at the beginning of the tape, they are recorded automatically.

#### Manual mode ("MANUAL" indicator lights):

In this mode you can manually record a tune number and Start ID in any desired position.

When recording music such as live music in which the next tune starts before the clapping from the previous tune ends completely, Start IDs may not be recorded if the deck is in auto mode. In cases such as this, record the tune numbers and Start IDs manually.

### Blank non-recorded sections and blank recorded sections

Blank non-recorded sections are sections in which nothing has been recorded.  
Blank recorded sections are sections which are recorded but contain no sound.

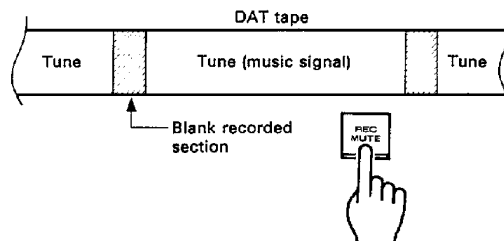

In contrast to conventional audio cassette tapes, blank non-recorded sections are not desirable on DAT tapes because they cause the deck to take a lot of time when searching for tune numbers (NBR) and make the total elapsed time (TOTAL TIME) (A TIME) data discontinuous. You should therefore be careful not to leave blank non-recorded sections in the middle of recorded DAT tapes.

### Key indicators on the main unit

The play key, record key, and pause key on the main unit each have an indicator.

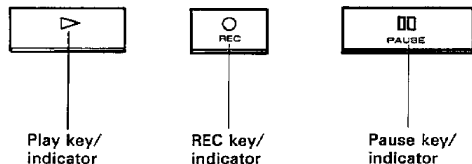

Each of the indicators lights when its function is operating. When one of these keys is pressed while another function is operating, the key enters standby mode and the key's indicator blinks.

When the other operation ends, the function of the pressed key starts operating. At this time, the key's indicator stops blinking and lights steadily. (Except for the REC key.)

#### Play indicator:

Lights during playback, playback fast-forward/rewind, and playback-pause mode.

#### Record indicator:

Lights during recording and record-pause mode.

#### Pause indicator:

Lights during playback-pause mode and record-pause mode.

#### Digital mode indicator ("DIGITAL"):

Lights when the input selector is set to a digital position (OPTICAL or COAXIAL).

Recording is not possible when this indicator blinks during recording, record-pause, or monitoring.

### THROUGH key

#### THROUGH



When this key is pressed, you can monitor both analog and digital input sources when the deck is in stop mode. Press again to cancel.

### TOC key



With DAT tapes containing a TOC (Table of Contents) such as commercially-available music tapes and tapes which have been renumbered (see page 25), you can display the total remaining time for approximately 5 seconds by pressing the remote control unit's TOC key. This key does not function with tapes which are not recorded with A TIME data.

# Recording/Deleting IDs (After-recording editing)

Make sure the tape's "accidental erasure protection slider" is closed.

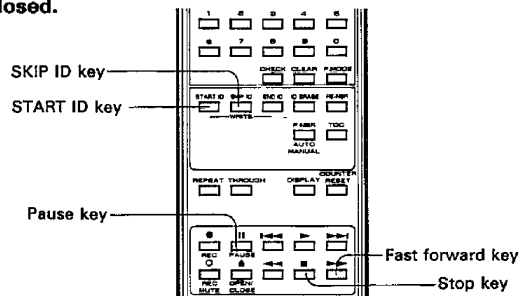
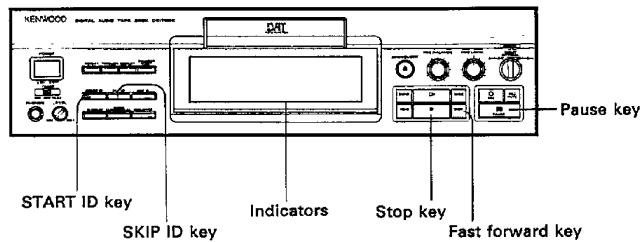

## ■ Recording a Start ID

**1** If the deck is in playback mode, put it in stop mode.



**2** Move to the position where the Start ID is to be recorded.

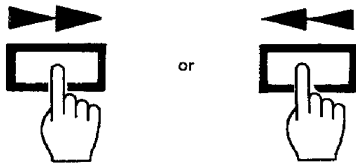

- Advance the tape to the position where you want to record the Start ID.

**3** Record the Start ID.

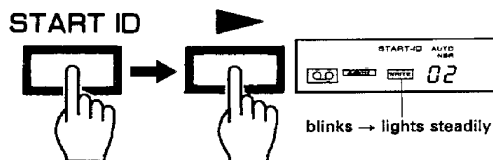

- You can record a Start ID at any desired position while the tape is playing.
- You must wait at least 18 seconds after the deck starts recording the Start ID before you can record the next Start ID.
- When a Start ID is recorded, the SINGLE TIME (P TIME) code which indicates the tune's elapsed time is rewritten starting from 0.

## ■ Recording a Skip ID

Use the Skip ID to skip over a section of the tape you do not want to listen to during playback.

**1** Put the deck in playback-pause mode.



**2** Move to the position where the Skip ID is to be recorded.

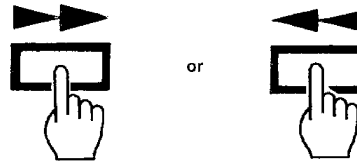

- Advance the tape to the position where you want to record the Start ID.

**3** Record the Skip ID.

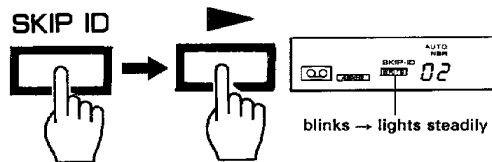

- Press at the position where you want the Skip ID to be recorded.
- You can record Skip IDs during recording as well as playback.
- When the SKIP ID key is pressed in playback-pause mode or record-pause mode, the Skip ID recording function enters standby mode and a Skip ID is recorded when the pause mode ends.
- When a Skip ID is detected during playback, the deck fast-forwards the tape to the next Start ID.



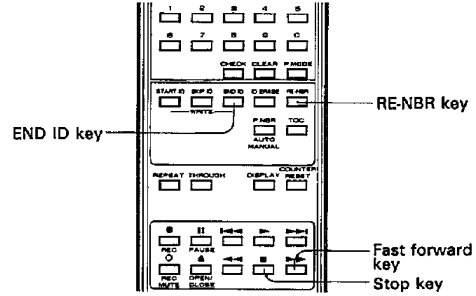
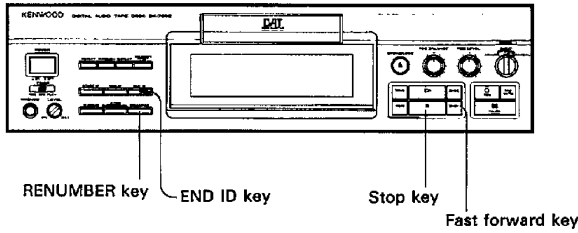

## ■ Recording an End ID

**1** Put the deck in playback-pause mode.

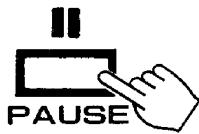

**2** Move to the position where the End ID is to be recorded.

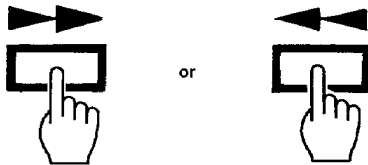

- Advance the tape to the position where you want to record the End ID. However, during after-recording editing, an End ID cannot be recorded nearby a non-recorded section of the tape.

**3** Record the End ID.

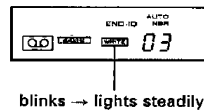
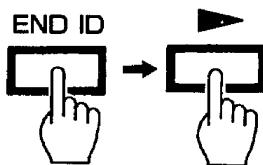

blinks → lights steadily

- If the END-ID indicator does not go off even when the END ID key is pressed, press ◀ key in step 2 to rewind the tape for about 9 seconds and press the END ID key again.

## ■ To rewrite tune numbers (renumbering)

**1** Put the deck in stop mode.

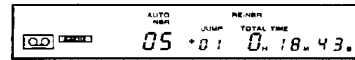

**2** Rewrite the tune numbers.



- Do not press the stop key until the renumbering operation is finished.
- The tape is rewound to the beginning and tune numbers are automatically rewritten in sequence at each Start ID location. When renumbering is completed, the tape is rewound to the beginning and TOC data is recorded at the start of the first tune.
- The "RE-NBR" indicator lights during the renumbering operation.

### ■ Erasing a Start ID

**1** Put the deck in pause mode.

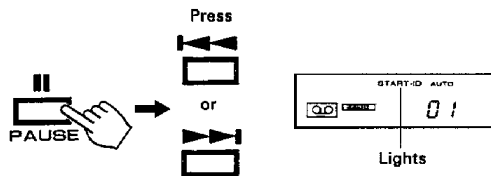

- Stop on the Start ID you want to erase.

**2** Erase the Start ID.

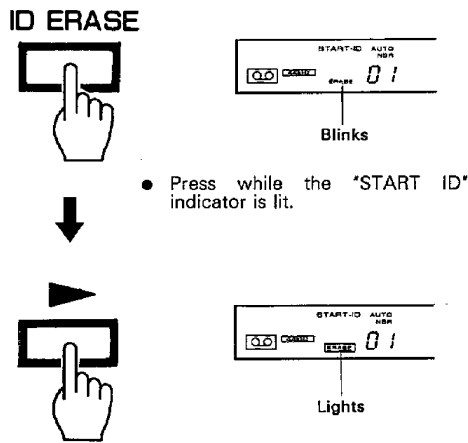

### ■ Erasing a Skip ID

**1** Put the deck in pause mode.

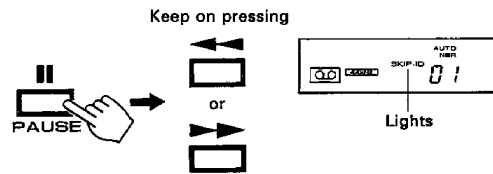

- Release the key when the SKIP ID indicator to be erased lights up.

**2** Erase the Skip ID.

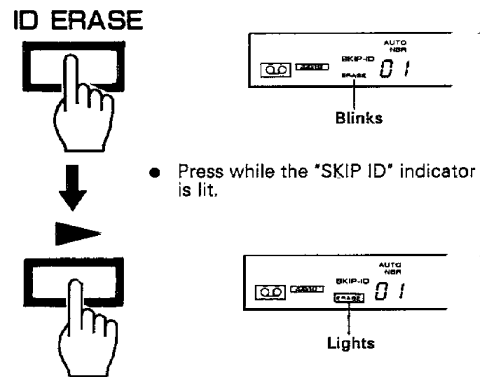

- The tape rewinds to the beginning of the Skip ID and the Skip ID is erased.
- If a Skip ID is recorded within an area where a Start ID is recorded, erasing one of the IDs will cause both IDs to be erased.

### ■ Erasing an End ID

**1** Set to stop mode./Search for End ID.

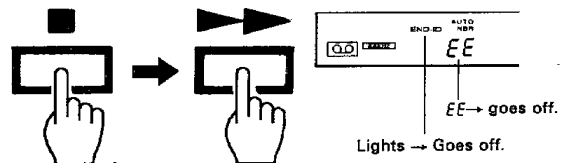

**2** Press the play key.



- Press while the "END ID" indicator is lit.

**3** Erase. ID ERASE

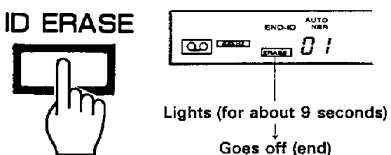

Note:  
When a Start ID is erased, the elapsed time (SINGLE TIME) (P TIME) of the corresponding tune is rewritten so that it continues from the previous tune.

# Using a timer

By connecting this unit to an audio timer, you can carry out timer playback (for wake-up music) and timer recording (for recording while you are out).

Use an audio timer if possible. Other types of timers such as kitchen timers can be used, but care is required since these timers do not turn the power back off once the power is turned on.

Be sure to read the timer's instruction manual before use.

## ■ Timer playback (wake-up music)

### 1 Connect the power cords.

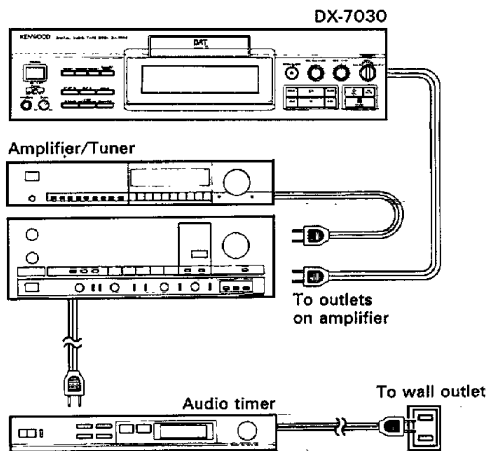

### 2 Turn on the power to each component.

### 3 Adjust the volume on the amplifier or receiver.

### 4 Rewind the tape to the start position.

### 5 Set the timer operation time.

- Set the playback start time using the timer's time setting keys.

### 6 Set the deck's TIMER switch to play mode.

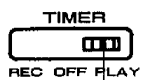

Set to PLAY.

- When the set time arrives, playback starts after a delay of about 10 seconds.
- When playback finishes, the tape rewinds automatically and stops.

## ■ Timer recording (recording while you are out)

### 1 Connect the timer.

- Connect the power cords of each component as shown in the illustration at the left.

### 2 Turn on the power to each component.

### 3 Select the input mode.

- Set the input selector on the amplifier or receiver to "TUNER".

### 4 Tune in the desired broadcast station.

- Tune in the desired station using the tuning knob (or buttons) on the tuner or receiver.

### 5 Adjust the recording level.

- Adjust the level using this unit's REC LEVEL control.
- When recording digitally, it is not necessary to adjust the recording level.

### 6 Lower the volume level.

- Set the volume control of the amplifier or receiver to "0".

### 7 Set the timer operation time.

- Set the recording start time using the timer's input keys.

### 8 Set the deck's TIMER switch to record mode.

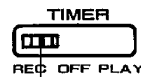

Set to REC.

- When the set time arrives, recording starts after a delay of about 15 seconds.
- Recording automatically stops at the end of the tape.
- P.NBR mode is set to MANUAL mode.

Note:  
When not carrying out timer playback or timer recording, set the TIMER switch to OFF.

## In case of difficulty

If your player should not perform as expected,, consult the table below to see if the problem can be corrected before seeking help from your dealer or service representative.

Symptom	Cause	Remedy
The power does not turn on even when the POWER switch is pressed.	<ul style="list-style-type: none"> <li>The power cord is not plugged securely into the outlet.</li> <li>The power cord is plugged into an outlet on the amplifier and the amplifier's power switch is turned OFF.</li> </ul>	<ul style="list-style-type: none"> <li>Plug the power cord securely into the AC outlet.</li> <li>Turn the amplifier's power switch ON.</li> </ul>
The inserted tape is ejected.	<ul style="list-style-type: none"> <li>The cassette tape is inserted incorrectly.</li> </ul>	<ul style="list-style-type: none"> <li>Correctly insert the tape.</li> </ul>
The deck does not operate even when an operation key is pressed.	<ul style="list-style-type: none"> <li>The deck or tape contains condensation.</li> <li>The deck will not operate for approximately 4 seconds after the power is turned on.</li> <li>The tape is broken.</li> </ul>	<ul style="list-style-type: none"> <li>Wait until the cassette (ON) indicator lights steadily.</li> <li>The deck can be operated after approx. four seconds elapse.</li> <li>Replace the tape.</li> </ul>
Recording or playback starts when the power is turned on.	<ul style="list-style-type: none"> <li>The TIMER switch is set to "REC" or "PLAY".</li> </ul>	<ul style="list-style-type: none"> <li>Set the TIMER switch to "OFF".</li> </ul>
The stop key and OPEN/CLOSE key do not function during recording or after-recording editing.	<ul style="list-style-type: none"> <li>These keys do not function when the "START ID" indicator is lit (approx. 9 seconds).</li> </ul>	<ul style="list-style-type: none"> <li>Operate the key after the "START ID" indicator goes out.</li> </ul>
Recording is not possible.	<ul style="list-style-type: none"> <li>The tape's "accidental erasure protection slider" is open.</li> <li>Nothing is connected to the rear panel's digital or analog recording (REC) jacks, or a signal is not being input.</li> <li>The deck is not properly connected to the amplifier.</li> <li>Copy-prohibit code is recorded in the digital signal.</li> </ul>	<ul style="list-style-type: none"> <li>Close the "accidental erasure protection slider."</li> <li>Connect a recording source to the recording (REC) jacks.</li> <li>Connect the deck and amplifier again correctly.</li> <li>Record in analog mode. (Refer to page 22.)</li> </ul>
Programmed tune selection and other methods of tune selection do not operate well.	<ul style="list-style-type: none"> <li>Tune numbers (NBR) and Start IDs are not recorded.</li> <li>A Start ID is not recorded for 9 seconds.</li> <li>A Start ID is very close to the next Start ID.</li> <li>Tune numbers (NBR) are not continuous.</li> </ul>	<ul style="list-style-type: none"> <li>Record tune numbers (NBR) and Start IDs.</li> <li>Erase the Start ID and record it again. (A Start ID may not be able to be erased if its recording time is too short.)</li> <li>Try to keep at least 30-40 seconds between Start IDs.</li> <li>Use the renumbering function to rewrite the tune numbers in a continuous sequence.</li> </ul>
Tape is rapidly advanced during playback.	<ul style="list-style-type: none"> <li>Unwanted SKIP ID is recorded.</li> </ul>	<ul style="list-style-type: none"> <li>Erase unnecessary Skip ID. (Refer to page 26.)</li> </ul>
Playback is not possible.	<ul style="list-style-type: none"> <li>Start ID is not recorded at the beginning of the tape.</li> </ul>	<ul style="list-style-type: none"> <li>Press the ►► key to advance the tape to the beginning of the recorded section and press the play key.</li> </ul>

Symptom	Cause	Remedy
<b>After-recording editing is not possible.</b>	<ul style="list-style-type: none"> <li>● The cassette tape's "accidental erasure protection slider" is open.</li> <li>● The tape in use is a commercially-available prerecorded music tape.</li> </ul>	<ul style="list-style-type: none"> <li>● Close the "accidental erasure protection slider."</li> <li>● After-recording editing is not possible with commercially-available prerecorded music tapes.</li> </ul>
<b>A tune number and Start ID cannot be recorded.</b>	<ul style="list-style-type: none"> <li>● A tune number and Start ID cannot be recorded within 18 seconds after the start of the previously recorded tune number and Start ID.</li> </ul>	<ul style="list-style-type: none"> <li>● Record the tune number and Start ID at least 18 seconds (30-40 seconds if possible) after the start of the previous tune number and Start ID.</li> </ul>
<b>Noise or distortion is noticed in the playback sound.</b>	<ul style="list-style-type: none"> <li>● The recording level is extremely high or too low.</li> <li>● The head section needs cleaning.</li> <li>● The tape is worn.</li> </ul>	<ul style="list-style-type: none"> <li>● Record the tape again at an appropriate recording level.</li> <li>● Clean the head using the commercially available DAT cleaning tape (except wet type) and try recording again. <ol style="list-style-type: none"> <li>1. Load the cleaning tape.</li> <li>2. Press the rec key and the advance the cleaning tape for about 10 seconds.</li> <li>3. Press the stop key and take out the cleaning tape.</li> </ol> </li> <li>● Use a new tape.</li> </ul>
<b>The recording level cannot be adjusted during digital recording.</b>	<ul style="list-style-type: none"> <li>● The recording level is set automatically.</li> </ul>	<ul style="list-style-type: none"> <li>● It is not necessary to set the recording level for digital recording.</li> </ul>

**Notes:**

1. Since this unit incorporates a microprocessor, external noise or interference may cause the unit to operate abnormally. If this should ever occur, press the POWER switch OFF and then press it ON again after a period of several seconds.
2. Do not use contact cleaner because it could cause a malfunction. Be specially careful against contact cleaners containing oil, for they may deform the plastic components.

# Specifications

## [Mechanisms/transport system]

Type .....	Digital audio tape deck with rotating head system
Heads .....	Two rotating heads (sputtered sendust heads)
Motors .....	(6 motors) DD motor (for capstan) DD motor (for drum) DC motor (for loading) × 4
Tape speed .....	8.15 mm/s
Recording time .....	120 minutes (with DR-120 tape)
Rewind time .....	approx. 40 sec (with 120-minute recorded tape)

## [Digital format]

No. of channels .....	2-channel stereo
Sampling frequency .....	Recording: 48 kHz, 32 kHz (digital input only) Playback: 48 kHz, 44.1 kHz, 32 kHz
No. of quantization bits .....	16-bit linear

## [Electrical characteristics]

Frequency response .....	2 Hz ~ 22 kHz
Signal to noise ratio .....	more than 93 dB
Dynamic range .....	more than 92 dB
Total harmonic distortion .....	less than 0.005%
Wow and flutter .....	below measurable limit

## [Input terminals]

Line input (analog signal recording) .....	500 mV, input impedance 10 k $\Omega$
Digital coaxial input .....	0.2 V (P-P), input impedance 75 $\Omega$
Digital optical input .....	-15 dBm ~ -24 dBm (660 nm)

## [Output terminals]

Line output (analog signal playback) .....	2 V RMS, output impedance 1 k $\Omega$
Digital coaxial output .....	0.5 V (P-P), output impedance 75 $\Omega$
Digital optical output .....	-18 dBm (wavelength 660 nm) rectangular type
Headphone output .....	20 mW (16 $\Omega$ ), stereo standard jack

## [General]

Power consumption .....	30 W
External dimensions .....	Width: 440 mm Height: 127 mm Depth: 370 mm
Weight (net) .....	9.6 kg

Note:  
Kenwood follows a policy of continuous advancements in development. For this reason specifications may be changed without notice.

**For the U.S.A.****FCC WARNING:**

This equipment may generate or use radio frequency energy. Changes or modifications to this equipment may cause harmful interference unless the modifications are expressly approved in the instruction manual. The user could lose the authority to operate this equipment if an unauthorized change or modification is made.

**NOTE:**

This equipment has been tested and found to comply with the limits for a Class B digital device, pursuant to Part 15 of the FCC Rules. These limits are designed to provide reasonable protection against harmful interference in a residential installation. This equipment may cause harmful interference to radio communications, if it is not installed and used in accordance with the instructions. However, there is no guarantee that interference will not occur in a particular installation. If this equipment does cause harmful interference to radio or television reception, which can be determined by turning the equipment off and on, the user is encouraged to try to correct the interference by one or more of the following measures:

- Reorient or relocate the receiving antenna.
- Increase the separation between the equipment and receiver.
- Connect the equipment into an outlet on a circuit different from that to which the receiver is connected.
- Consult the dealer or an experienced radio/TV technician for help.

**For CANADA****DOC REGULATION**

"This digital apparatus does not exceed the CLASS B limits for radio noise emissions from digital apparatus as set out in the radio interference regulations of the Canadian Department of Communications."

**Note:**

The unit's power supply is secondarily connected. Note following. The unit is not completely disconnected from the mains as long as the power cord is connected to a wall outlet.

**Observera:**

Apparatens strömförsörjning kopplas från sekundärt. V.g. ge akt på följande. Apparaten frånkopplas inte helt och hållet från strömmätet medan apparatens nätsladd är ansluten till växelströmsuttaget.

**Huom:**

Virta yksikköön on kytketty pois sekundaaripuoleta. Huomioi seuraava. Tämä yksikkö ei ole kokonaan kypketty pois pää virranjakajasta kun pää katkaisin on liitettyä virtatiiriin.

**Bemærk:**

Strømmen til apparatet afbrydes på den sekundære side. Vær opmærksom på følgende. Denne enhed er ikke fullstendig koblet fra lysnettet så længe stikket er tilsluttet stikkontakten.

**Anmerkning:**

Strømmen til apparatet er slått av på sekundærsiden. Vær oppmerksom på det følgende. Dette apparatet koples ikke fullstendig fra nettet så lenge støpselet står i en stikkontakt, selv om strømbryteren settes i av - stilling.

KENWOOD